

**smeg**  
technology with style





# MTE40



Product Family	Minibars
Installation	Free standing
Category	One Door
Cooling type	Thermo-Electric
Defrost	Automatic
Hinge type	Standard
Hinge position	Right
Reversible door	Yes
EAN code	8017709312541



## Aesthetics

Colour	Black
Material	Plastic
Handle	Integrated
Logo colour	Chrome
Side material	Steel
Side colour	Black
Logo	Silk screen

## Refrigerator compartment features



No. of adjustable shelves	2
Type of adjustable shelves	Glass
Internal light in fridge	Yes
Type of internal light (fridge)	LED

## Refrigerator Inner Door

Number of adjustable door shelves	1
No. of bottle shelves	1

## Other technical features

Refrigerant gas type	R600a	Refrigerant Quantity (gr)	25 g
----------------------	-------	---------------------------	------

---

## Performance / Energy Label NEW 2019

---



<b>Annual energy consumption</b>	161 kWh/a
<b>Energy efficiency class</b>	G
<b>Airborne acoustical noise emission class</b>	A
<b>Total net volume</b>	32 l
<b>Sum of the volumes of the chill compartment(s) and the unfrozen compartment(s)</b>	32 l
<b>Total gross volume</b>	40 l
<b>Climate class</b>	N
<b>EEL</b>	205 %

---

## Electrical Connection

---

<b>Plug</b>	(F;E) Schuko
<b>Electrical connection rating</b>	65 W
<b>Voltage (V)</b>	230 V
<b>Frequency (Hz)</b>	50/60 Hz
<b>Power supply cable length</b>	150 cm

---

## Logistic Information

---

<b>Width</b>	405 mm
<b>Depth without handle</b>	440 mm
<b>Height</b>	550 mm
<b>Product width with maximum doors opening</b>	795 mm
<b>Product depth with doors open at 90°</b>	825 mm

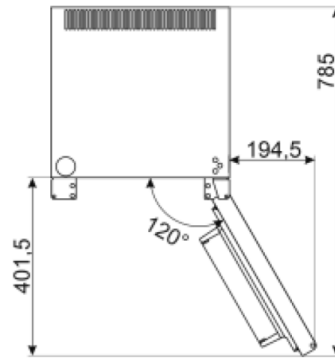
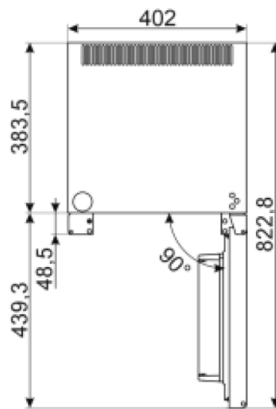
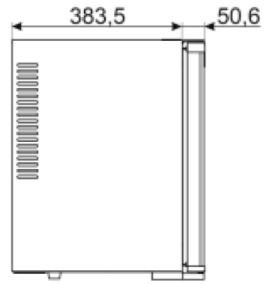
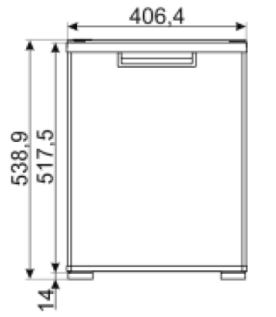

## Symbols glossary (TT)

---



The automatic defrost system works by automatically defrosting at regular intervals eliminating the need to defrost altogether.



Energy efficiency class G



LED interior lighting: is a more energy efficient and long lasting way of illuminating the interior of the appliance.

# FAB5RRD5



<b>Product Family</b>	Refrigerators
<b>Installation</b>	Free standing
<b>Category</b>	One Door
<b>Cooling type</b>	Static
<b>Defrost</b>	Automatic
<b>Hinge type</b>	Standard
<b>Hinge position</b>	Right
<b>EAN code</b>	8017709299613



## Aesthetics

<b>Colour</b>	Red	<b>Logo colour</b>	Chrome
<b>Finishing</b>	Glossy	<b>Side material</b>	Steel
<b>Aesthetics</b>	50's Style	<b>Side colour</b>	Red
<b>Design</b>	Rounded	<b>Logo</b>	Applied
<b>Material</b>	Heat-moulded	<b>Door shelves profile color</b>	Chrome
<b>Handle</b>	External	<b>Drawers profile color</b>	Chrome
<b>Handle type</b>	Fixed	<b>Color of glass shelf profile</b>	Chrome
<b>Handle colour</b>	Chrome		

## Refrigerator compartment features



<b>No. of adjustable shelves</b>	2	<b>Internal light in fridge</b>	Yes
<b>Type of adjustable shelves</b>	Glass	<b>Type of internal light (fridge)</b>	LED

## Refrigerator Inner Door

<b>Number of adjustable door shelves</b>	1	<b>No. of bottle shelves</b>	1
<b>Adjustable door shelves with wire support</b>	Yes	<b>Bottle shelves with wire support</b>	Yes

## Other technical features

Type of temperature control	Electronic
Refrigerant gas type	R600a
Type of compressor	Standard
Refrigerant Quantity (gr)	19 g
Foam agent	Cyclopentane

## Performance / Energy Label



Category of the household refrigerating appliance model	2 - Refrigerator-cellar, Cellar and Wine storage appliances	Cellar compartment - Storage Volume	34 l
Airborne acoustical noise emissions	40 dB(A) re 1pW	Climatic class	SN, N, ST, T
Energy efficiency class	A+++	Storage volume Cellar compartment	38 l
Energy efficiency Index EEI	21.1 %	Total gross volume	38 l
Annual energy consumption	54 kWh/a	Total storage volume	34 l

## Performance / Energy Label NEW 2019



Annual energy consumption	61 kWh/a	Sum of the volumes of the chill compartment(s) and the unfrozen compartment(s)	34 l
Energy efficiency class	D	Climate class	SN, N, ST, T
Airborne acoustical noise emission class	C	EEI	79 %
Total net volume	34 l		

## Electrical Connection

Plug	(F;E) Schuko	Voltage (V)	220-240 V
Electrical connection rating	60 W	Frequency (Hz)	50/60 Hz
Current	0.22 A	Power supply cable length	100 cm

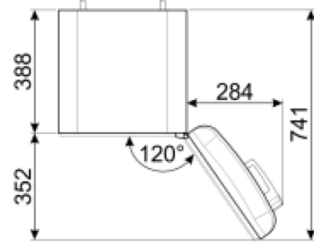
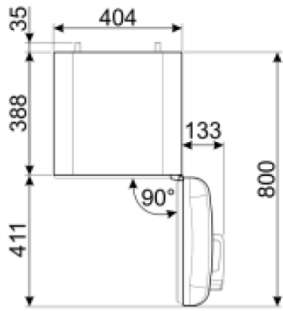
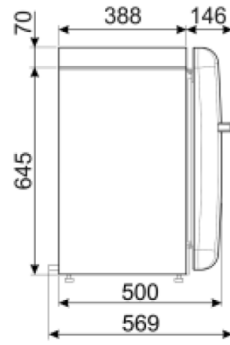
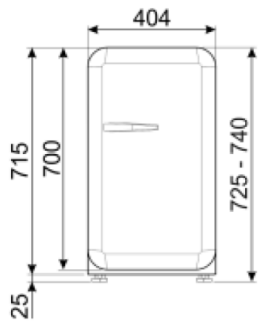



## Not included accessories

---

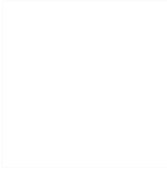





**KITCABLE90UK**

Cable with IEC connector and UK plug

## Symbols glossary (TT)

---

- |   |  |
|---|--|
|  <p>The automatic defrost system works by automatically defrosting at regular intervals eliminating the need to defrost altogether.</p> |  <p>Energy efficiency class D</p>   |
|  <p>A+++: Appliances with this symbol can reduce energy consumption by a further 30% from the standard A energy rating.</p>             |  <p>LED interior lighting: is a more energy efficient and long lasting way of illuminating the interior of the appliance.</p> |

# RETRO MİNİ SOĞUTUCU (FAB5 SERİSİ)

★ Kompresörsüz özel soğutma sistemi sayesinde duyulmayacak kadar sessiz çalışma özelliği

FAB5RNE - MİNİ SOĞUTUCU - SİYAH



FAB5RNE - Siyah, Sağ menteşe  
FAB5LNE - Siyah, Sol menteşe

FAB5RR - MİNİ SOĞUTUCU - KIRMIZI



FAB5RR - Kırmızı, Sağ menteşe  
FAB5LR - Kırmızı, Sol menteşe

FAB5RP - MİNİ SOĞUTUCU - KREM



FAB5RP - Krem, Sağ menteşe  
FAB5LP - Krem, Sol menteşe

FAB5RO - MİNİ SOĞUTUCU - TURUNCU



FAB5RO - Turuncu, Sağ menteşe  
FAB5LO - Turuncu, Sol menteşe

FAB5RPB - MİNİ SOĞUTUCU - P. MAVİ



FAB5RPB - Pastel Mavi, Sağ menteşe  
FAB5LPB - Pastel Mavi, Sol menteşe

FAB5RPG - MİNİ SOĞUTUCU - P. YEŞİL



FAB5RPG - Pastel Yeşil, Sağ menteşe  
FAB5LPG - Pastel Yeşil, Sol menteşe

FAB5RPK - MİNİ SOĞUTUCU - PEMBE



FAB5RPK - Pembe, Sağ menteşe  
FAB5LPK - Pembe, Sol menteşe

FAB5RYW - MİNİ SOĞUTUCU - SARI



FAB5RYW - Sarı, Sağ menteşe  
FAB5LYW - Sarı, Sol menteşe

- LED iç aydınlatma
- Kapasite: 42 litre
- Manuel defrost (Buz çözme)
- Enerji tüketimi: Yılda 278 kW

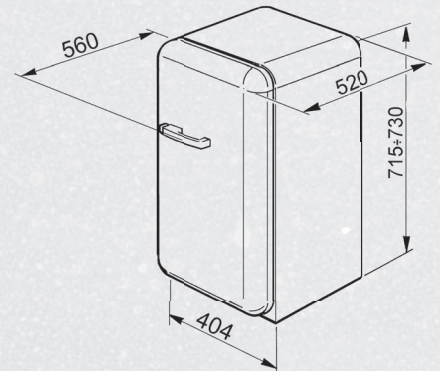



# MİNİ SOĞUTUCULAR

★ Kompresörsüz özel soğutma sistemi sayesinde duyulmayacak kadar sessiz çalışma özelliği

## ABM42 - MİNİ SOĞUTUCU - 40 litre toplam hacim

Cihaz Ölçüsü (y x e x d) mm: 560 x 400 x 440

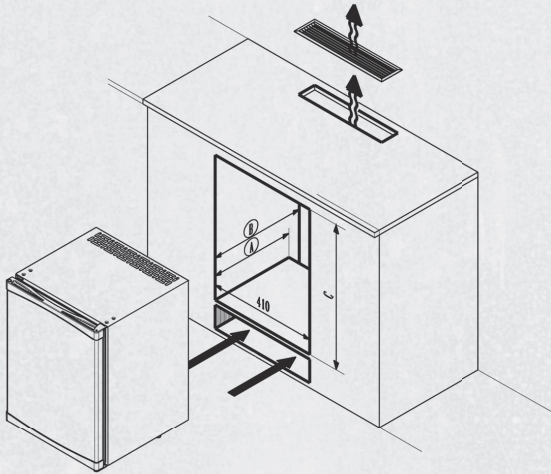

Model	A	B	C
ABM42	405	460	570
ABM32 / 32GD	365	440	500

## ABM32 - MİNİ SOĞUTUCU - 30 litre toplam hacim

Cihaz Ölçüsü (y x e x d) mm: 490 x 400 x 420



- Özel tasarlanmış ultra sessiz mini soğutucu
- Ankastre kullanıma uygun\*
- Özel tasarlanmış led iç aydınlatma
- Manuel termostat ayarlı
- Değiştirilebilir kapı yönü
- Otomatik defrost düğmesi
- Ayarlanabilir iç raflar ve kapı rafları

\* Ahşap kabin kapağının, soğutucu kapısına montajı yapılarak kullanılabilir.

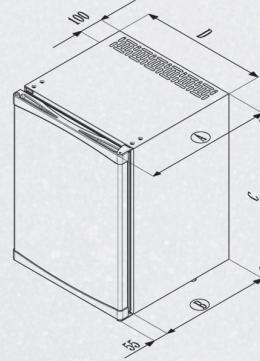

Model	A	B	C	D
ABM42	440	385	560	400
ABM32 / 32GD	420	365	490	400

